

HYDRODIGIT-S1

User manual v1.9



B METERS srl

Via Friuli, 3
33050 Gonars (UD)
Italy

Tel: +39 0432 931415
Tel: +39 0432 1690412
Fax: +39 0432 992661

Sales/info: info@bmeters.com
Support: ticket@bmeters.com
www.bmeters.com

Index

1. Content	2	4. Device display loop	6
Design	2	5. Error message	7
Device dial	2	6. Batteries safety guidelines	7
Functionality	2	7. Information for correct disposal of the product ...	8
Types	3	8. Technical data	8
Packing content	3	Annex A	9
Safety conditions	3		
Environmental conditions	3		
Installation requirements.....	4		
2. Function	4		
Display.....	4		
3. Radio parameters	5		
Delivery status	5		
Operating mode - Radio activation.....	5		
Wireless M-Bus compatible (low antenna only).....	5		
Wireless M-Bus OMS v4	5		
LoRaWan	6		
LoRaWan + Wireless M-Bus OMS v4.....	6		

1. Content

Design

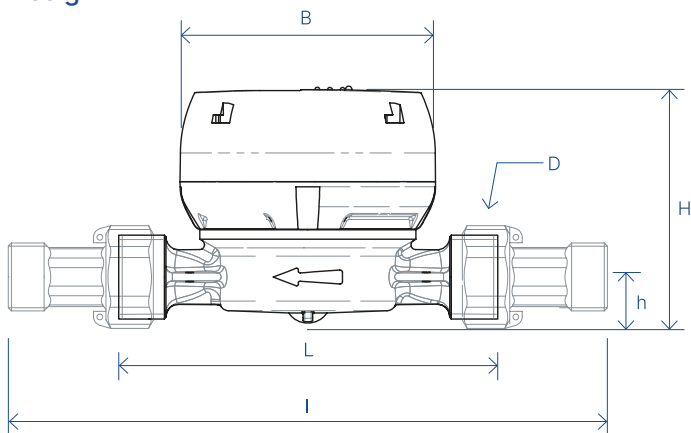

Size		15mm (1/2")				20mm (3/4")	
		80	110	145	165	130	190
L	mm	80	110	145	165	130	190
B	mm	81					
I	mm	160	190	225	245	228	288
D	in	3/4"				1"	
H	mm	77	74		77		
h	mm	13	14		17		

Device Dial

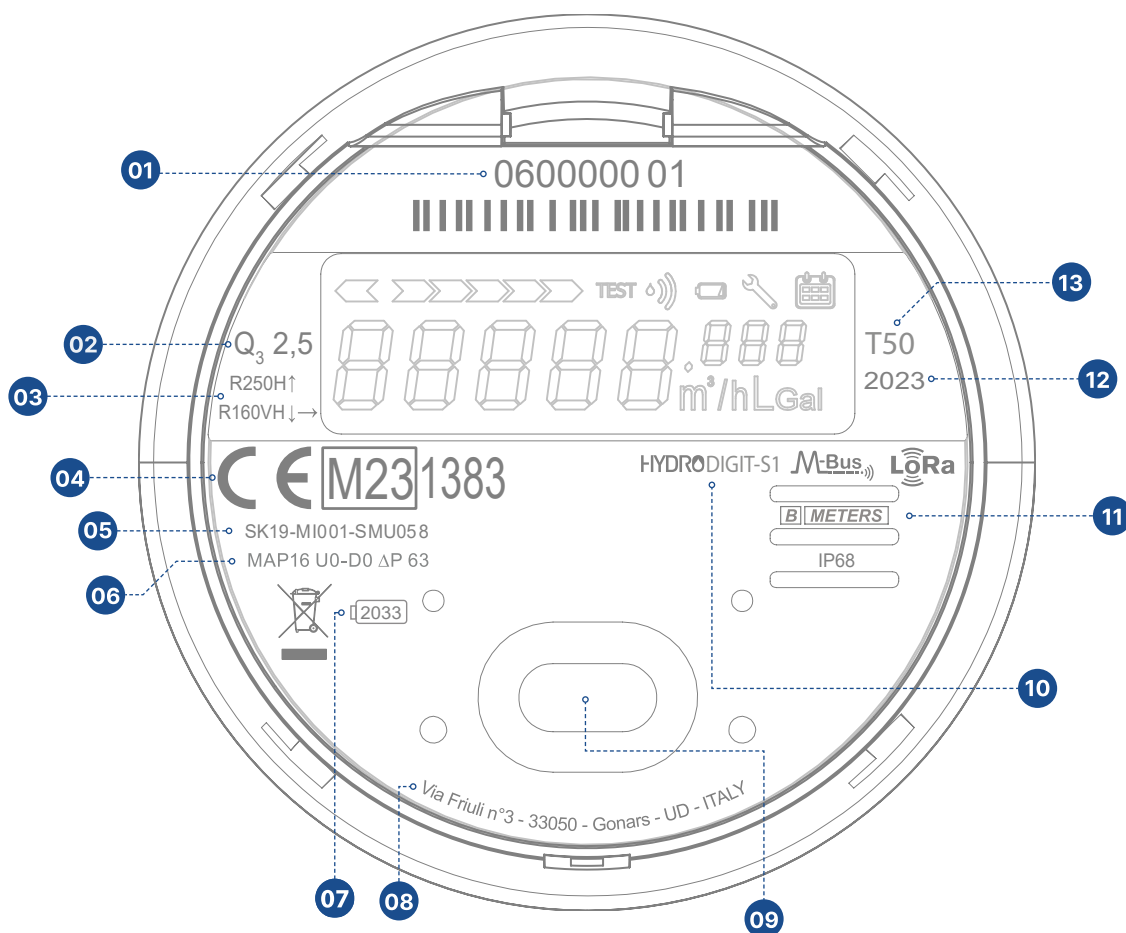

- 01. Serial number
- 02. Q3 meter size
- 03. Measuring class/installation positioning allowed:
RxxH - horizontal installation
RxxVH - vertical and horizontal installation
- 04. CE marking
- 05. Type approval number
- 06. Maximum allowed working pressure
- 07. Battery expiration year
- 08. Company address
- 09. Optical interface
- 10. Type
- 11. Manufacturer
- 12. Year of production
- 13. Temperature class

Functionality

The water meter HYDRODIGIT-S1 is a single jet water meter with digital display and rotary induction detection system, antimagnetic. It is available for both hot and cold water.

Types

The device is available in four versions:

- Wireless MBUS OMS compatible (low antenna only)
- Wireless MBUS OMS v4 (COMBO, output configuration Wireless MBUS OMS v4 only)
- LoRaWAN (COMBO, output configuration LoRaWAN only)
- LoRaWAN + Wireless MBUS OMS v4 (COMBO, output configuration LoraWAN + Wireless MBUS OMS v4)

Packaging content

- HYDRODIGIT water meter
- Connection gaskets*
- Connectors*
- Seal*

*if ordered with the meter

Environmental conditions

- Storage: from -20°C to +70°C
- Operating: from +1°C to +55°C
- The storage period must not exceed 1 year
- The water meters are precision devices and must be protected from shocks and vibration





















Safety instructions















Read all the instructions carefully before proceeding with the installation! Failure to comply with one or more procedures contained in the manual can be dangerous and cause damage to things and people. It is recommended to comply with all applicable safety and accident prevention laws.

 **Warning:** this symbol highlights the instructions to be strictly followed for the correct functioning of the smart water meter.

 **Danger:** items marked with this symbol contain information that must be followed carefully to avoid dangerous situations.

 **Notes:** the notes indicated by this symbol contain suggestions to keep in mind when using the smart water meter.

	Comply with the national regulations on water measurement.
	Comply with the technical requirements for the installation of electrical equipment.
	The device complies with the requirements of Directive 2014/30/EU of the European Council on electromagnetic compatibility, Directive 2014/35/EU on electrical safety and Directive RED 2014/53/EU.
	The warranty and validity of the verification before expires if the identification plate and seals attached to the instrument are removed or damaged.
	Air transportation of tools with active radio interface prohibited.
	To clean the device externally use a soft cloth and moistened with water. Do not wash with high pressure jets or immerse the device in water. Avoid contact with oils and solvent. Do not use alcohol or detergents.
	Remove the product from the package only at installation to protect it from damage and dirt.
	If several devices are installed in a unit, the installation conditions must be the same for all devices in order to ensure the most equitable billing of consumption possible.
	Carefully observe the instructions in the data sheet, instruction manual, application notes and lid. Failure to comply with the operating conditions may result in situations of danger and forfeiture of all claims of liability for defects and liability on the basis of any guarantees expressly granted. Further information is available on www.bmeters.com
	Dispose of replaced devices and defective components in accordance with current environmental regulations.
	Do not damage the device casing. In the event of blunt objects hitting the front of the display, it can be damaged irretrievably and lose the degree of protection IP65 or IP68. Install in areas protected against impact. In case of breakage of the protective casing contact customer support.
	The meter is not suitable for running water in central heating systems but is suitable for clean water.
	Pay attention to sharp edges or sharp projections in the threads, flanges and measuring tube. Therefore, it is recommended to wear protective gloves.
	After installation of the meter perform a leak test of the system.
	The meter must be mounted or removed only after the system has been depressurized.
	The meter does not have lightning protection.
	Do not expose the meter to sun and heat sources. Do not throw into the fire.
	The device shall be used in such a way as to minimise the potential for human contact during normal operation. In order to avoid the possibility of exceeding the limits of exposure to radio frequencies, the human proximity to receivers with integrated antenna should not be less than 20 cm (8 inches) during normal operation.
	Keep away from children.
	Water meters do not require special protection against electrical interference; however, electromagnetic interference must be avoided.

	If transmission network interfaces are used, especially when cables are routed outside the building, use more protection against electrical interference.
	In case of danger of frost, empty the system and, if necessary, remove the meter.
	Rinse the pipes thoroughly before installing the meter.
	The meter shall be installed in the direction of the arrow on the meter housing, corresponding to the direction of the flow.
	Avoid collecting air bubbles in the meter during the installation process.
	The meter shall not be subjected to mechanical stress when installed in the pipe.
	The meter shall be installed in a way that it is protected from all external impurities and contamination.
	Remove the old seals and clean the sealing surfaces.
	Slightly grease the sealing surfaces (use grease approved for drinking water and acid-free).
	The meter can only be installed in frost-proof areas.
	Use only the gaskets supplied (the gaskets must not get into the pipe). Seals provided on site must be fit for purpose and comply with local guidelines and directives. No liability is accepted for consequential damage resulting from the use of third-party seals, such as corrosion of seal surfaces and threads.
	Manually and simultaneously screw the meter fittings on both sides and then tighten in opposite directions using a suitable tool.
	Slowly fill the pipe with water after installation.
	The meter must be protected against pressure shocks in the pipe.

The table below displays the troubleshooting procedures:

Problem	Cause	Solution
Display off	Batteries may be damaged or discharged.	Notify the service department
Damaged casing	Possible external impact or fall to the ground	
Lower case body separated by electronic unit	Tampering by third parties or strong external impacts	
Open and visible electronic unit		
No consumption accounted	Tampering by third parties, strong external impacts or flow detection sensor damage	
Does not transmit radio signal	Flow failure of 5 liters or the batteries may be damaged or discharged	
Error '____ L Err' present on display	Possible leakage in the water supply/plant/taps	Check for the absence of leaks in the water supply/system/tap
Error '____ O Err' present on display	Range higher than Q ₄ for 10 consecutive minutes	Check the water supply and meter installation
Error '____ I Err' present on display	Continuous reverse flow greater than 20 liters	

Installation requirements

All versions of the water meter can be installed both horizontally and vertically. For better yield, horizontal installation is preferable, with the turbine axis perpendicular to the ground and the reading mechanism facing upwards.

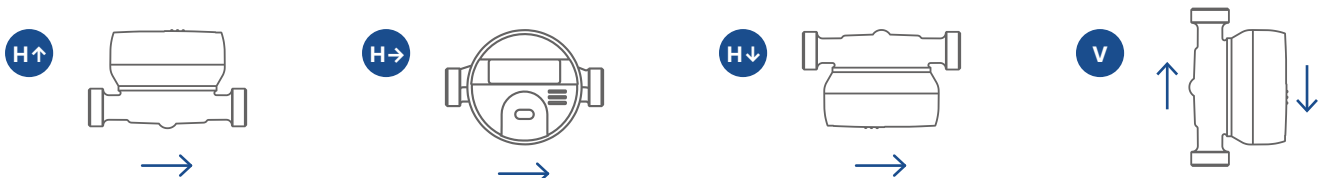

2. Functioning

Display

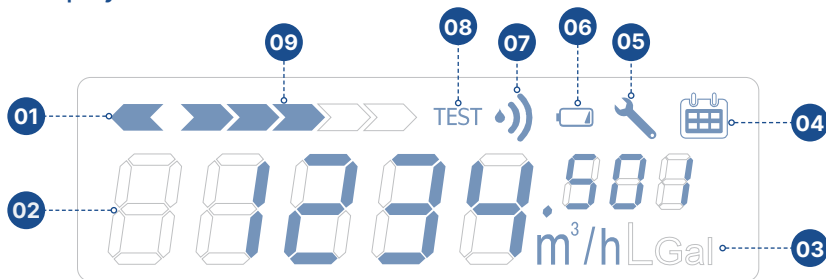

Note: representation for illustrative purposes only.

- 01. Reverse flow indication (appears if it detects a flow)
- 02. Main display (m³) decimal position (liters)
- 03. Units of measurement
- 04. Historical data
- 05. Configuration mode
- 06. End of battery life
- 07. Radio transmission status
- 08. Test mode
- 09. Instantaneous flow rate (appears if it detects a flow)

3. Radio parameters

Delivery status

The factory setting is power saving mode. In this mode, the radio transmission function is not yet activated, to save battery power during shipping and storage. The device can account for consumption and send any errors (e.g. reverse flow for incorrect installation).

Operation mode - Radio activation

Once the water meter is installed, the radio transmission is activated automatically, after ±5 liters of water passed through the device (LoRaWAN: start sending join requests - wM-Bus: radio activation). The display shows the flow/direction level if the flow rate is detected.

Wireless M-Bus compatible

As soon as the radio operation mode is activated, the meter sends a radio telegram according to Wireless M-Bus, T1 mode (one-way transmission). Preconfigured radio parameters (**AMR mode**):

- Transmission frequency: every 200 seconds (default);
- Transmission interval: every day, from 0 to 24 h;
- Encryption: disabled (default);
- No historical data;
- Data transmitted: volume, effective date and time, reverse flow, alarms;

It is possible to modify the configuration parameters in Walk-By mode with a USB IR interface (UC-Cable) and B Metering software.

Walk-By mode parameters:

- Transmitting frequency: every 60 seconds (current values);
- Transmission interval: every day, 6 a.m. to 8 p.m.;
- Encryption: Enabled/Disabled;
- Historical data (12 months);
- Transmitted data: volume, effective date and time, reverse flow, alarms, leakage alarm date, fraud alarm date (Q_{max} or reverse flow).

Radio parameters - Wireless M-Bus OMS v4 (COMBO, output configuration only Wireless M-BUS OMS v4)

As soon as the radio operation mode is activated, the meter sends a radio telegram according to Wireless M-Bus OMS v4, T1 mode (unidirectional and synchronous transmission). Preconfigured radio parameters (**AMR mode and OMSv4 certified synchronous**):

- Transmission frequency: every 200 seconds (current values);
- Transmission interval: every day, 0 to 24 h;
- Encryption: disabled (default);
- No historical data;
- Transmitted data: volume, effective date and time, reverse flow, alarms;
- Cut-off: disabled*

**the meter has a low cut-off flow of 3 l/h for Q₃ = 2.5 m³/h and 5 l/h for 4.0 m³/h*

It is possible to modify the configuration parameters in Walk-By mode with a USB IR interface (UC-Cable) and B Metering software:

- Transmission frequency: configurable (minimum 60 seconds);
- Transmission interval: Monday to Sunday, max. 12 hours per day (selectable range);
- Possibility to select a 24-hour time slot with the following mandatory conditions:
 - › transmission frequency > 300 seconds (synchronous);
 - › disabled historical data;
- Encryption: enabled/disabled;
- Historical data (12 months);
- Transmitted data (depends on the selected parameters): volume, effective date and time, reverse flow, alarms, leakage alarm date, fraud alarm date (Q_{max} overflow or reverse flow detection);
- Cut-off enabled/disabled*.

**the meter has a low cut-off flow of 3 l/h for Q₃ = 2.5 m³/h and 5 l/h for 4.0 m³/h*

LoRaWAN (COMBO, only output configuration LoRaWAN)

As soon as the radio operation mode is activated, the meter sends join requests to the provisioned Network Server, according to LoRaWAN transmission standards. During the join process, the radio icon on the display will flash every second. If successful, the icon will remain fixed and stable, otherwise it will turn off. **Preconfigured radio parameters:**

- Transmission frequency: every 12 hours (current values);
- Transmission interval: every day, from 0 to 24 h;
- Transmitted data: volume, reverse flow, diameter, medium, alarms;
- Cut-off: disabled*.

It is possible to modify some configuration parameters with a USB IR interface (B METERS mod. UC-Cable) and B Metering software:

- Transmission frequency: every 6 hours (current values);
- Sending temperature data;
- Transmitted data: volume, reverse flow, diameter, medium, alarms, temperature (if enabled);
- ABP mode and related keys;
- Cut-off enabled/disabled*.

**the meter has a low cut-off flow of 3 l/h for Q3 = 2.5 m³/h and 5 l/h for 4.0 m³/h*

LoRaWAN + Wireless M-Bus OMS v4 (COMBO, output configuration LoraWAN + Wireless M-Bus OMS v4)

As soon as the radio operation mode is activated, the meter sends join requests to the provisioned Network Server, according to LoRaWAN transmission standards. In addition, it activates transmission according to the Wireless M-Bus OMS v4 T1 mode standard (unidirectional but asynchronous transmission). During the join process, the radio icon on the display will flash every second. If successful, the icon will remain fixed and stable, otherwise it will turn off. For radio parameters, refer to the individual modes described above (always refer to the sales order). Default parameters:

- wM-Bus: transmission every 60 seconds, 8-18, from Monday to Friday, historical data, encryption disabled, cut-off disabled;
- LoRaWAN: transmission every 12 hours, every day, from 0 to 24h.

4. Device display loop

Device display	Display time	Example of description
	10 seconds	Consumption: 12,561 m³ Flow: active Radio: active
	2 seconds	Fu_01_01 firmware version (Combo 003 will be shown in the combo)
		
	2 seconds	"ALL ON" segment test
	2 seconds	"ALL OFF" segment test
	2 seconds	Error message

5. Error messages

If an error occurs, an error message is displayed. The error message will be integrated into the display loop of the device for **2 seconds**.

I Reverse flow

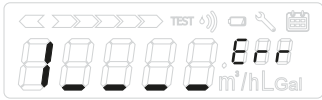

Reverse flow detected, a flow was detected and the counter installation in the opposite direction. The error is triggered after a continuous reverse flow of more than 20 liters. **Recovery:** reset the

alarm via LoRa downlink (if in LoRa version), or directly in the field with the IR interface and software. **Resolution:** check the water network

O Maximum flow rate exceeded



Water meters were used in improper conditions, the flow rate has exceeded the operating conditions. The guarantee of manufacturer is invalidated. The error is activated after the meter operates at one flow rate higher than Q4

for 10 consecutive minutes. **Resolution:** Check the water supply. **Reset:** Reset the alarm via downlink LoRa (if in LoRa version), or directly in the field with the IR interface and software.

B Burst



High consumption detected in a short time slot. This is probably related to a fault/breakage in the water mains. If the scope of the meter remains continuously above Q3 for 30 minutes,

the alarm is set. **Resolution:** Check the water supply. **Reset:** the alarm resets automatically when the flow rate drops below 0.5*Q3

R Reverse Installation



The meter begins to detect flow in the opposite direction. This is probably due to incorrect installation. Only during the first installation, if the absolute count (positive count - reverse count) is equal to 0 liters and a reverse flow (>8 liters)

is detected, the alarm is activated. **Resolution:** Check the meter installation. **Reset:** Automatically resets when flow is in the correct direction.

Radio telegram I O B R: The payload contains the status of the alarm. After recovery, the status is updated in the radio telegram.

L Loss













A continuous flow is detected for a long time. This is probably related to a leak in the water supply. The meter detects a continuous flow of >0.5*Q1 for 12 hours. **Resolution:** check the absence of

leaks in the water network/system/taps. **Recovery:** Automatically recovers when a flow interruption occurs.

Radio telegram L: The payload contains the status of the alarm and the date the alarm was triggered. After the alarm is restored, the date changes to the date of deactivation.

6. Batteries safety guidelines

The water meter constantly monitors the status of the battery (maximum life: 10 years*) and signals the imminent discharge by displaying the icon  on the display. The report takes place one year before the total discharge. Non replaceable batteries.

	The meter uses non-rechargeable batteries that, if tampered with, can be potentially dangerous. To reduce the risks, refer to the following precautions:
	Do not recharge or replace batteries;
	Do not open, scratch or damage batteries;
	Do not create short circuits on the batteries;
	Do not expose batteries to temperatures above 85°C;
	Do not puncture, crush or cut batteries, this may cause an explosion or the leakage of flammable gases or liquids.
	Do not use open flames near the device;
	Do not put in contact with water;
	Do not expose batteries to an environment with extremely low pressures, this could cause an explosion or the leakage of flammable gases or liquids

*Battery life is highly dependent on the working time window, set during the setup process, and environmental conditions. The battery life estimate is provided by the configuration software.

7. Information for proper disposal

 This product falls within the scope of Directive 2012/19/EU regarding the management of waste electrical and electronic equipment (WEEE). The device must not be disposed of with household waste as it is made up of various materials that can be recycled at appropriate facilities. Inquire through the municipal authority regarding the location of the ecological platforms suitable for receiving the product for disposal and its subsequent correct recycling. The product is not potentially dangerous for human health and the environment, but if abandoned in the environment it has a negative impact on the ecosystem. The crossed-out bin symbol, present on the label on the appliance, indicates the compliance of this product with the legislation relating to waste electrical and electronic equipment. Leaving the equipment in the environment or illegally disposing of it is punishable by law.

8. Technical data

Model	HYDRODIGIT-S1
Metrology class/permitted installations	R400H, R160V ↓ → R250H, R160V ↓ → R160H, R160V ↓ → Depending on the requests submitted when ordering
Flow detection technology	Turbine reading via inductive system
Temperature class	T50 cold water, T30-90 hot water
Display	LCD, 8 digits + icons
Degree of protection	IP68*
Local interface	Optical interface IR IEC 62056-21
Radio Standard	Depending on the version: - Wireless MBUS EN 13757-4 OMS compatible (low antenna only); - COMBO - output configuration: Wireless MBUS EN 13757-4 OMS v4; - COMBO - output configuration: LoRaWAN; - COMBO - output configuration: LoRaWAN + Wireless MBUS EN 13757-4 OMS v4.
Radio frequency	868 MHz
Radio range / radio power	Wireless MBUS: 300 metri** LoRaWAN: 5 Km**
Battery life	max 10 years***
Cut-off	disabled, if enabled the water meter has a low cut-off flow of 3 l/h for Q3 = 2.5 m ³ /h and 5 l/h for 4.0 m ³ /h

*IP68: Maximum 24 hours continuous immersion at 1m depth. Note: in case of damage caused by involuntary impact, the meter must be replaced with a new one, to restore the degree of protection.

** In optimal propagation conditions, the radio range depends on the physical conditions (building constructions, climatic conditions...) where the propagation of the radio signal

can therefore vary.

*** Battery life is highly dependent on the working time window, set during the setup process, and environmental conditions. The battery life estimate is provided by the configuration software.



EU DECLARATION OF CONFORMITY

dichiarazione di conformità CE

Water meter product type/model:
Modello di contatore per acqua:

HYDRODIGIT-S1

Name and address of the manufacturer:
Nome e indirizzo del fabbricante

BMETERS S.r.l. Via del Friuli, 3 – 33050 Gonars (UDINE) ITALY

This declaration of conformity is issued under the sole responsibility of the manufacturer.
La presente dichiarazione di conformità è emessa sotto la responsabilità del fabbricante.

Object of declaration:
Oggetto della dichiarazione:

Water Meter, single-jet, electronic indicating device
Contatore per acqua, getto singolo, dispositivo di indicazione elettronico

Above mentioned object is in conformity with relevant EU harmonization legislation:
L'oggetto sopra menzionato è conforme alla normativa di armonizzazione dell'UE pertinente:

Directive No. 2014/32/EU (MID) and 2014/30/EU (EMC) and 2014/35/EU (LVD) and 2014/53/EU (RED) and 2011/65/EU (RoHS)
Direttiva No. 2014/32/UE (MID) e 2014/30/UE (EMC) e 2014/35/UE (LVD) e 2014/53/UE (RED) e 2011/65/UE (RoHS)

Relevant harmonized standards and normative documents and references to the other technical specifications used for declaration:
Norme armonizzate pertinenti e documenti normativi e riferimenti alle altre specifiche tecniche utilizzate per la dichiarazione:

EN ISO 4064-1:2017	EN 14154-1:2005+A2:2011	OIML R 49-1:2013
EN ISO 4064-2:2017	EN 14154-2:2005+A2:2011	OIML R 49-2:2013
EN ISO 4064-3:2017	EN 14154-3:2005+A2:2011	OIML R 49-3:2013
EN ISO 4064-5:2017	Welmec Guide 7.2 (2020)	OIML R 49-1:2006
ETSI EN 300 220-2 v3.2.1	EN 55032:2015+AC:2016+A11:2020+A1:2020	OIML R 49-2:2004
ETSI EN 300 220-1 v3.1.1	EN 55035:2017-A11:2020	EN IEC 62368-1:2020+A11:2020+AC:2020
ETSI EN 301 489-3 v 2.1.1	IEC 61000-3-2:2018+AMD1:2020	EN 62479:2010
ETSI EN 301 489-1 v2.2.3	IEC61000-3-3:2013+AMD1:2017+AMD2:2021	

Name and number of notified body:
Nome e numero dell'organismo notificato:

SMU Slovenský metrologický ústav, NB 1781, Karloveska 63
84255, Bratislava 4, Slovenska Republika

Certificate issued:
Certificato emesso:

EU type certification in accordance with Module B of Directive No. 2014/32/EU
Certificazione UE di tipo in conformità al Modulo B della Direttiva n. 2014/32/UE

Issue the Certificate No:
Numero del certificato emesso:

SK 19-MI001-SMU058

Name and number of notified body:
Nome e numero dell'organismo notificato:

CMI Český metrologický institut, NB 1383 Okružní 31
638 00 Brno Czech Republic

Certificate issued:
Certificato emesso:

Certification of production, final product inspection and testing in accordance with Module D of Directive No. 2014/32/EU
Certificazione della produzione, ispezione del prodotto finito e collaudo in conformità al Modulo D della Direttiva n. 2014/32/UE

Issue the Certificate No:
Numero del certificato emesso:

0119-SJ-A011-08

Signed by the General Manager on behalf of BMETERS S.r.l.:
*Firma del Direttore generale
Per conto di BMETERS S.r.l.:*

Mr. Mauro Budai

B. METERS s.r.l.
 Via Friuli, 3
 33050 GONARS (UD) C.F. e P. IVA 01750460307

Place and date of declaration issue:
Luogo e data di emissione della dichiarazione:

Gonars, Italy, January 08, 2024
Gonars, Italia, 08 Gennaio 2024